

信号区

A

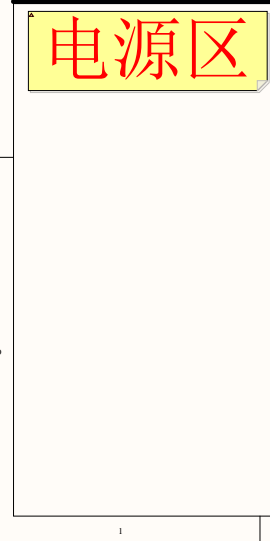

B

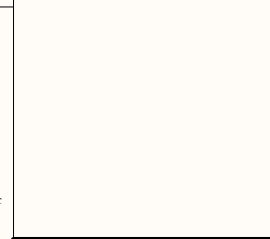
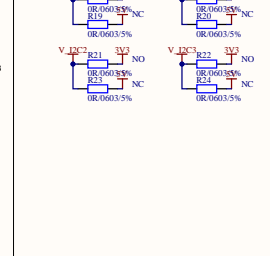
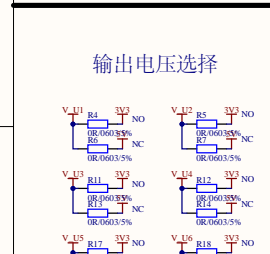
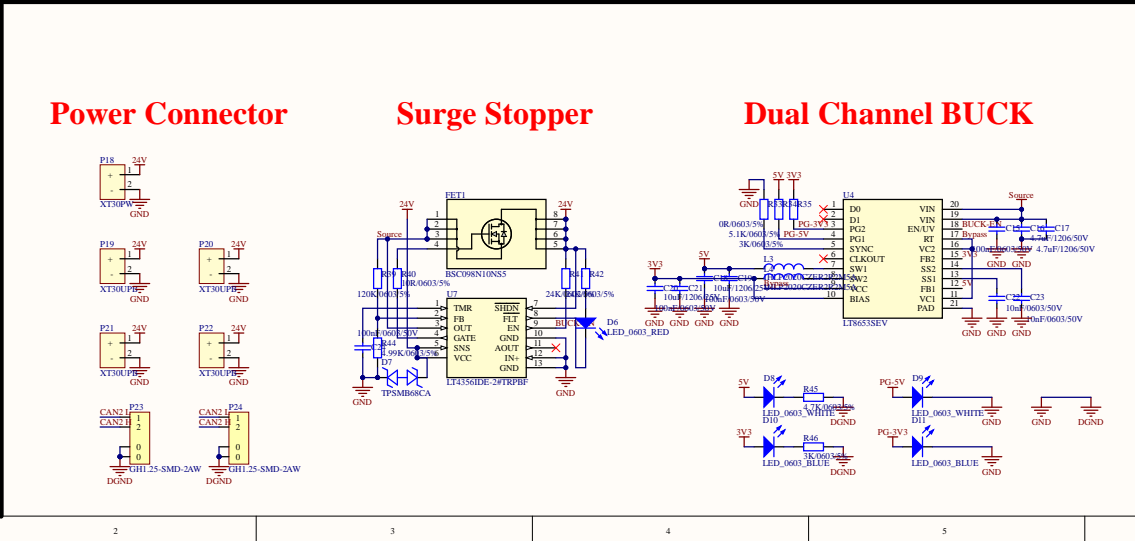
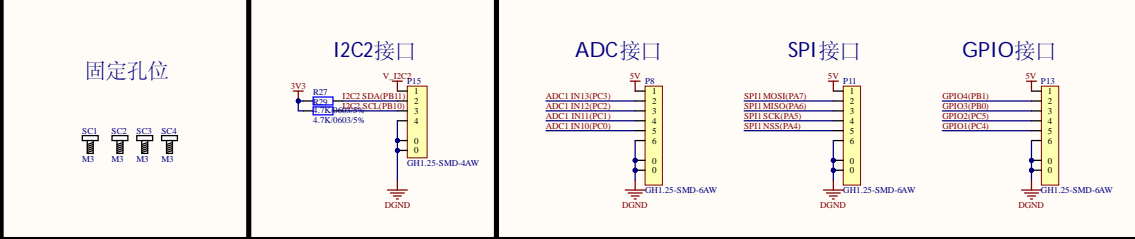
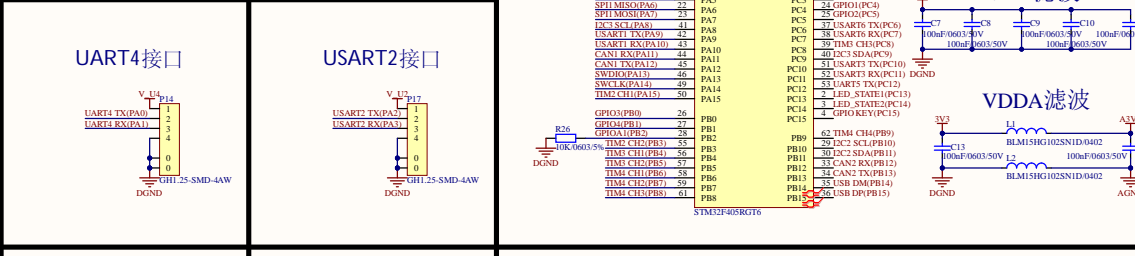
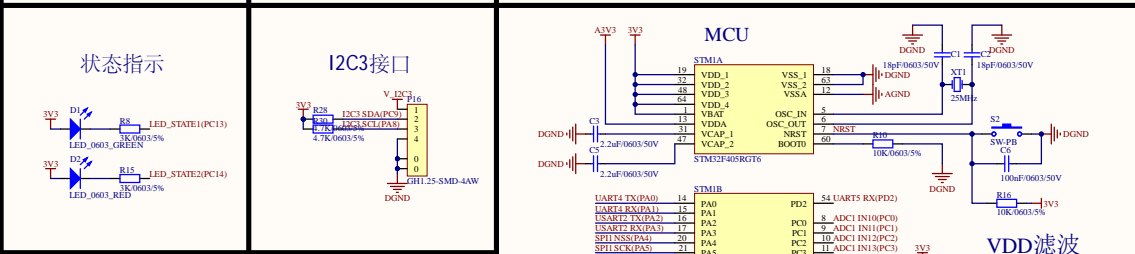
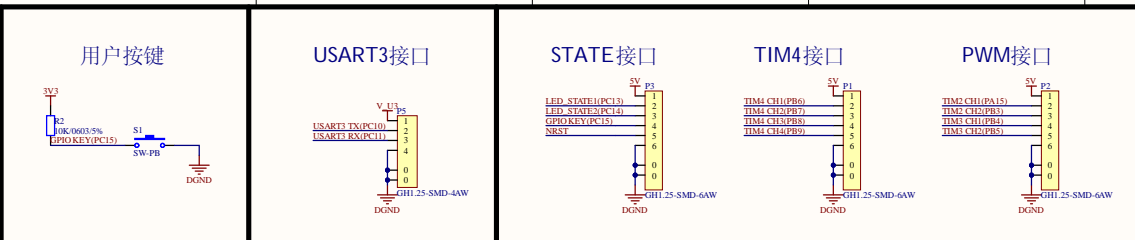

C

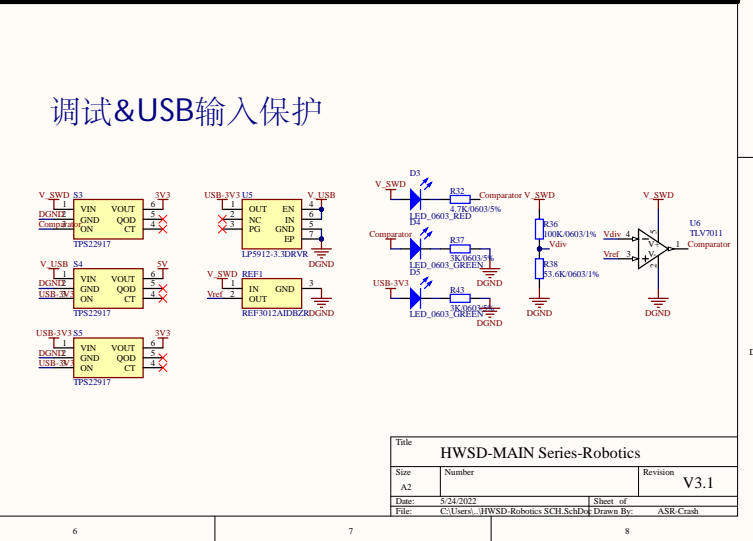
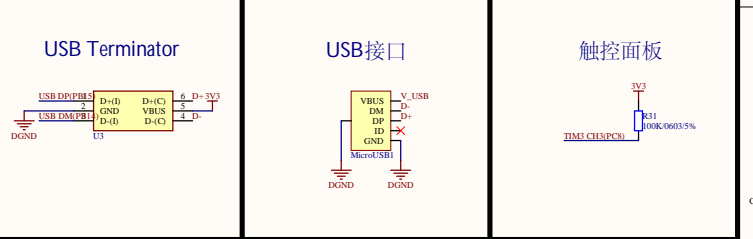
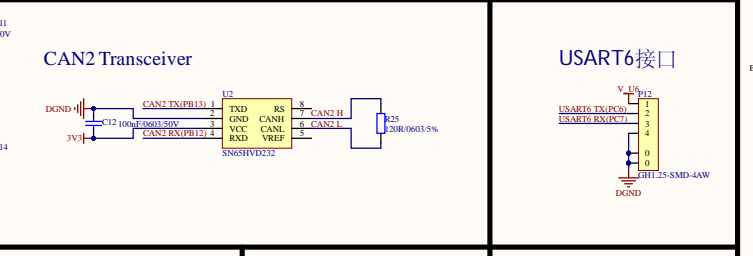
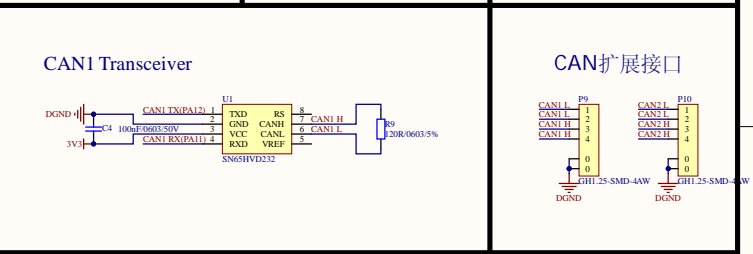
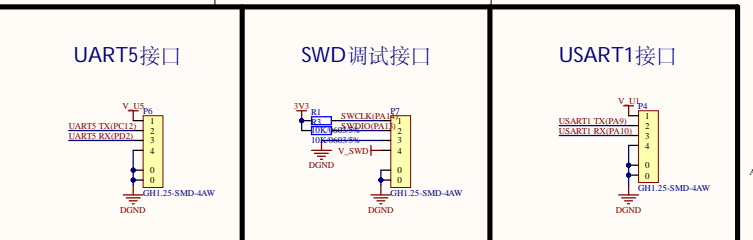

D

| | | |
|--|-----------|---------------------|
| Title: HWSD-MAIN Series-Robotics | | |
| Size: A2 | Number: | Revision: V3.1 |
| Date: 5/24/2022 | Sheet of: | Drawn By: ASR-Crash |
| File: C:\Users\HWSD-Robotics\SCH\SchD4 | Sheet of: | |